

**LÜZUMLU
ÖZEL
TAKIMLAR**

DİREKSİYON ve ÖN DÜZEN

P 3041 Çolak rod çektirmesi

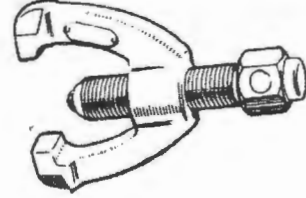

CP 3045 Direksiyon simidi çektirmesi
P 3066 Kutu burç çektirmesi
P 3070 Kapak flanjlı buç çektirmesi

P 3087 Sektör mil yağ keçesi takıcısı

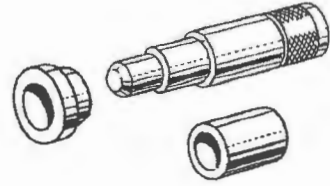

S 166—A Rotül çektirmesi
S 160 Rod başı çektirmesi

OTOSAN Ön amortisör helazon yayı sökme ve takma aleti

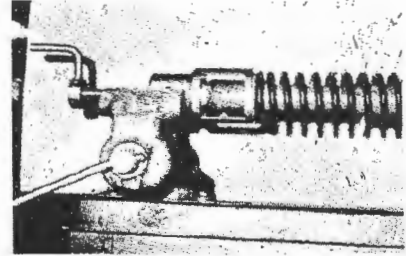

DİFERANSİYEL

550 Aks mili keçesi takma zımbası

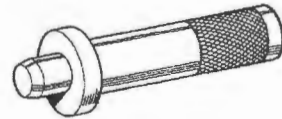

3072 Aks mili ve keçesi çektirmesi (Ana Takım)

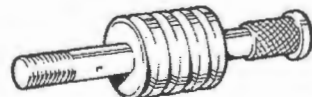

P 3072—3 Aks mili keçesi çekirme adaptörü

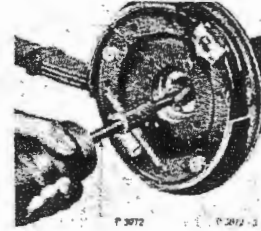

P 4000—27/A İstavroz kutusu yan bilyalı yatak çekirmesi adaptörü



P 4000—28 Mahruti dip bilyalı yatağı çıkartma adaptörü (iki parçalı bilezik)

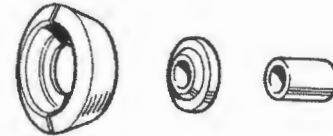

P 4008 Ayna dişli baklas kontrol saati (Ana Takım)

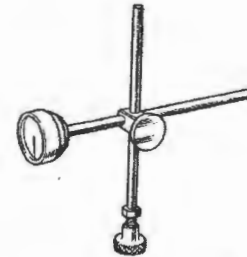

P 4009 Ayna dişli kutu yan yatak yayılma kontrol aleti (Ana Takım)

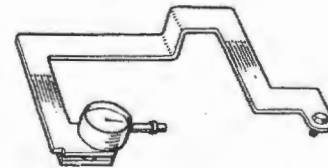

P 4013—3 Mahruti dişli mili dip ve uç bilyalı yatak zarflarını oturtma takımı

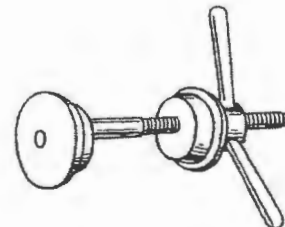

P 4015—A Mahruti dişli mili keçe ve ön bilya yatak zarfını çıkartma takımı

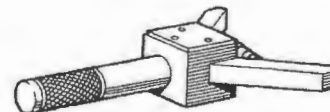

P 4028

Mahrutli dişli mili flanj tutma anahtarı

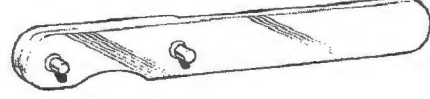

CP 4030

Mahrutli dişli milli yatakları ön yük kontrol kantarı

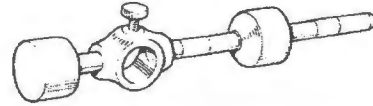

P 4030—1

Kantar adaptörü

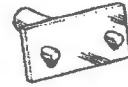

P 4075

Derinlik şim kalınlığı tesbit aleti

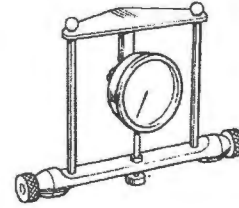

P 4075—4

Derinlik master şim kalınlığı tesbit adaptörü

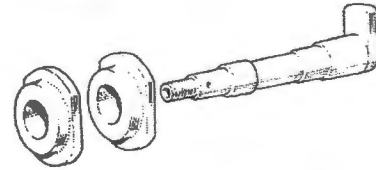

P 4077—A

Differansiyel göbeği adaptörü (Sehpaya bağlamak için)

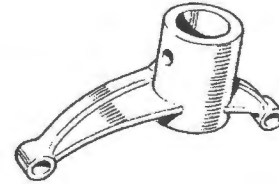

P 4079

Bilya ayar somun anahtarı

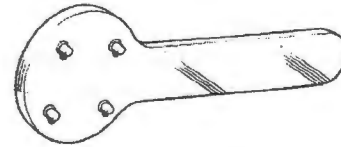

P 4080

Özel tampon (istavroz kutusu ayna dişliye)



ARKA AKS MİLİ

370

Taban plâkası

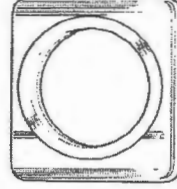

3072

Çekiçli çektirme (Ana Takım)

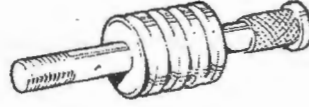

3072—2

Adaptör

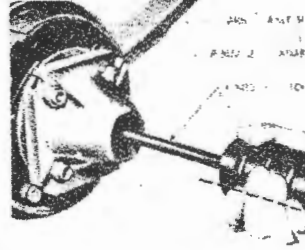

4084

Basınç göstergesi 1200 lb 544 Kgr.

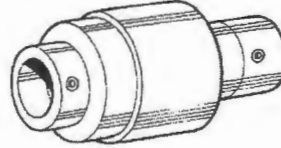

4090—2

Yatak ve keçe takma adaptörü

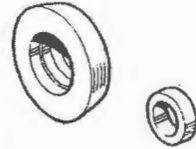

4090—6

Yatak ve bilezik çektirme adaptörü

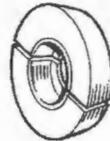

38U3

Piston segmanı sıkma kelepçeli
(60 ile 125 mm)

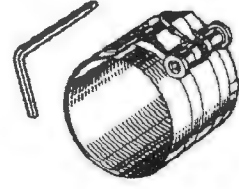

200B

Motor bağlama ve tamir sehpası

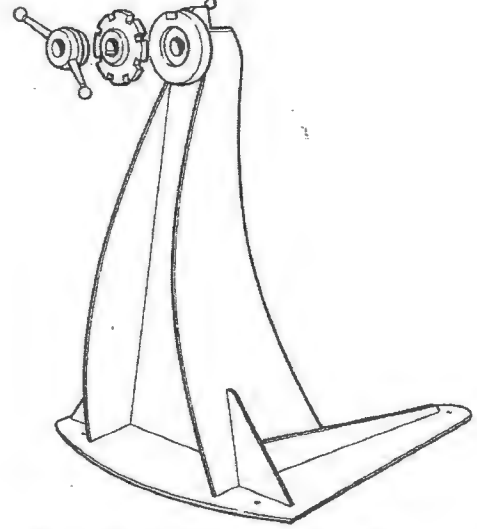

500X

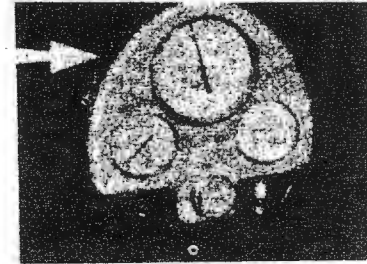

M O T Ö R

512

Piston sıklık ölçme kantarı

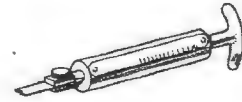

P 4008

Volant salgısı kontrol aleti (saatli)

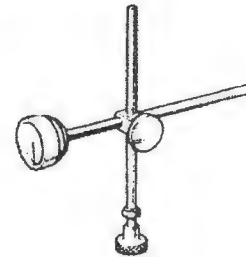

PT 4063

Silindir kapak yerleştirme klavuz saplamaları



P 6031 Eksantrik mili yatakları çekilmesi (Ana Takım)

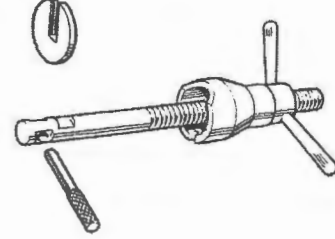

P 6031-3 Eksantrik mili yatakları çekirme adaptörü

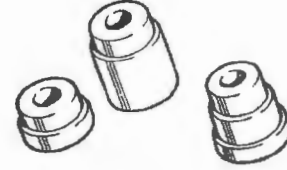

CP 6032-A/B Krank mili dişli takıcısı

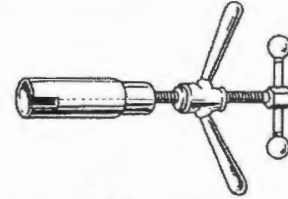

CP 6041 Krank mili kasnak çekilmesi

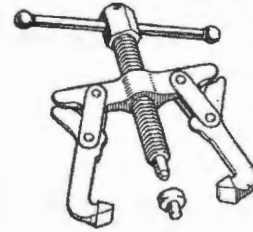

P 6056 Supap sapı yatağı raybası



316-X Subap yuva kesici ana kolu

316-X

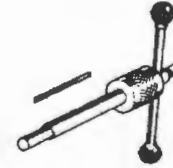

316-10 Subap yuva merkezlendirme mili

316-10

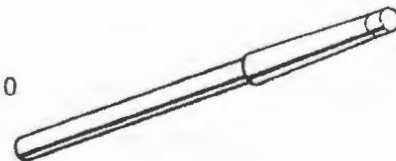

15.7

317-20 Egzost subabı yuva kesicisi 45°

317-20

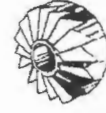

317-25 Emme subabı yuva kesicisi 45°

317-25



317T-20 Emme subabı yuva kesicisi

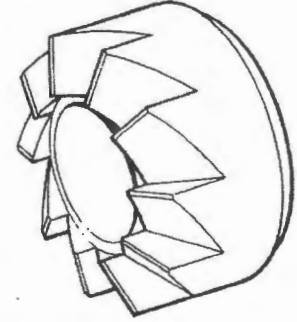

317T-25 Emme subabı yuva kesicisi 15°

317-T25



317-P20 Egzost subabı yuva kesici 75°

317-P20



317-P22 Emme subabı yuva kesici 75°

317-P22

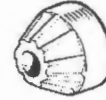

317-G20 Egzost subabı oturma yüzeyi parlaklık giderici 45°

317-G20



317-G25 Emme subabı oturma yüzeyi parlaklık giderici 45°

317-G25



P 6107 Motör sehpaı adaptörü

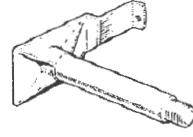

P 6115—A Motör kaldırma sehpaı

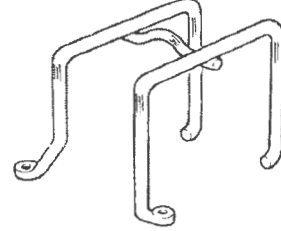

P 6116 Krank mili dişli çekirtmesi

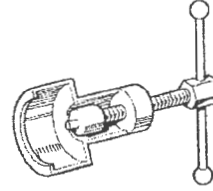

P 6118—A Supap çıkartma (Ana Takım)

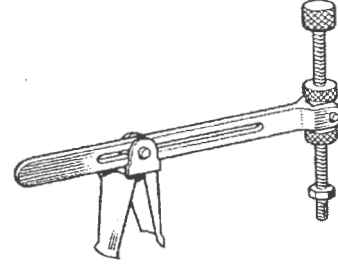

P 6118—3/A Supap çıkartma takım adaptörü.



C.6147

Krank arka yağ keçesi merkezlendirme aparatı

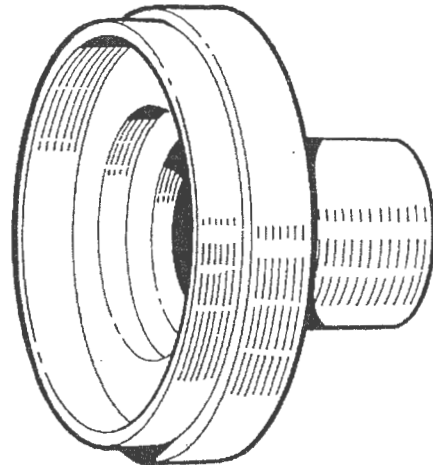

15.9

CP.6150

Krank mili ön yağ keçesi merkezlendirme aparatı

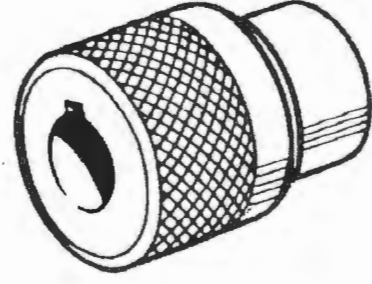

CP. 6150

P.6161

Krank mili ön yağ keçesi sökme ve takma aparatı

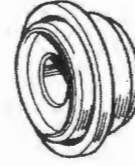

CP.6165A

Krank arka yağ keçesi sökme ve takma aparatı

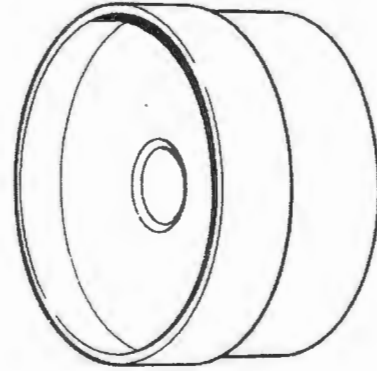

P.6171

Motor kaldırma ara braketi

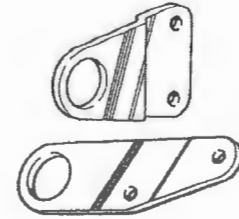

P.6550

P.7137

Debreyaj balatası merkezlendirme mili

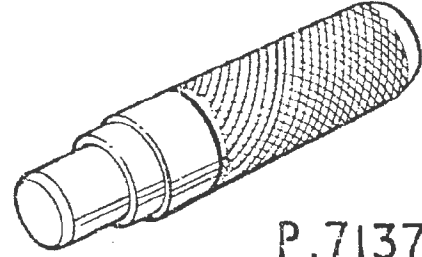

P.7137

7600 B

Volant rulmanı sökme ana kolu

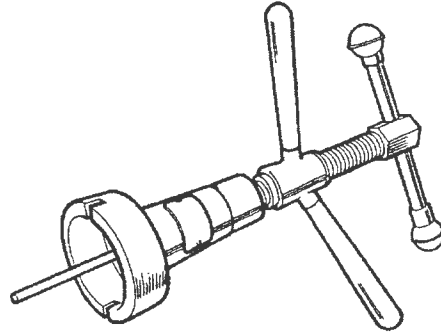

CP.7600-6

Volant rulmanı sökme aparatı (7600 A veya B)
ile beraber kullanılır

21-036

CP-7600-6

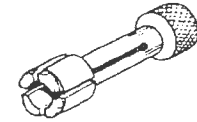

CP.7600A

Volant rulmanı sökme ana kolu

7600-A

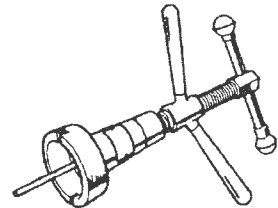

ŞANJIMAN ve DEBRİYAJ

- | | | |
|-------------|---|--|
| 370 | Taban plâkası | |
| P 4000—29 | Prizdirek bilyası geçirme adaptörü
(P 4096—6 ve 370 No. lu takımlar ile kullanılır) | |
| P 4000—31/A | Gamalı mil bilya takıcı | |
| P 4090—3 | İki parçalı adaptör (ikinci vites dişlisi bir ve ikinci vites senkromeç tertibatını gamalı milden çıkartmak için) | |
| P 4090—7/A | Birinci vites dişli çıkartıcı | |
| P 7038 | Kuyruk yatağı takma mili | |
| P 7043 | Geri vites dişli mili çekirtmesi | |

SU POMPASI

CPT 8000 Çektirme (Ana Takım)

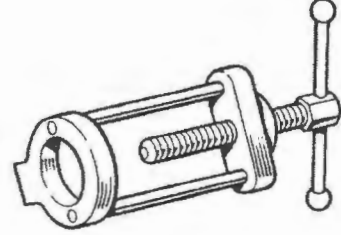

P 8000—4/a 2 parçalı bilezik
 P 8000—4/b Mil
 P 8000—4/e Tampon
 P 8000—4/d Adaptör



DİSTRİBÜTÖR ve ŞARJ SİSTEMİ

CP 9501 Platin çekiç. yayı kontrol kantarı



CP 9504 Şarj dinamo madeni yastık vidaları için özel
 tornavida
 CP 9505 Arka kapak burç raybalama (Ana Takım)
 CP 9505—1 Arka kapak burç raybası

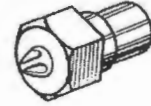

CP 9507 Arka kapak burç çıkartma ve takıcı

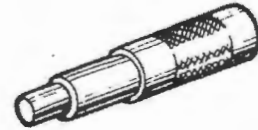

CP 9509 Şarj dinamosu ve Marş motörü madeni yastıkları
 sıkıştırma aleti

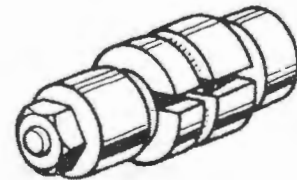

P 7066 Segman pensesi

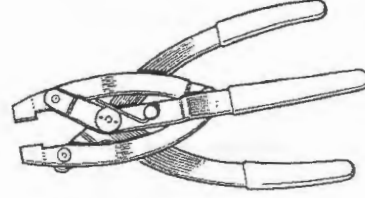

P 7091—A Debriyaj diski merkezlendirme mili

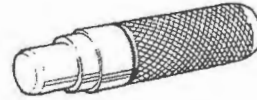

P 7093 Kilid sürgüsü takma klavuzu

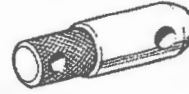

P 7095 Kuyruk keçesi takma mili

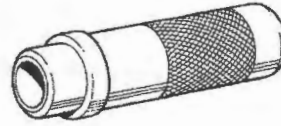

P 7098 Gamalı mil somun anahtarı



P 7113 Grup dişlisi muvakkat mili



P 7657 Kuyruk keçesi çekirtmesi (Ana Takım)

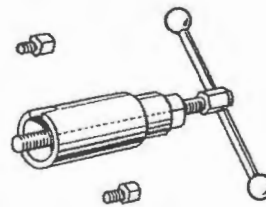

P 7657—4 Kuyruk keçesi çekirtme adaptörü

